

629

COBRA

Elio Martinelli – 1968

martinelli luce®

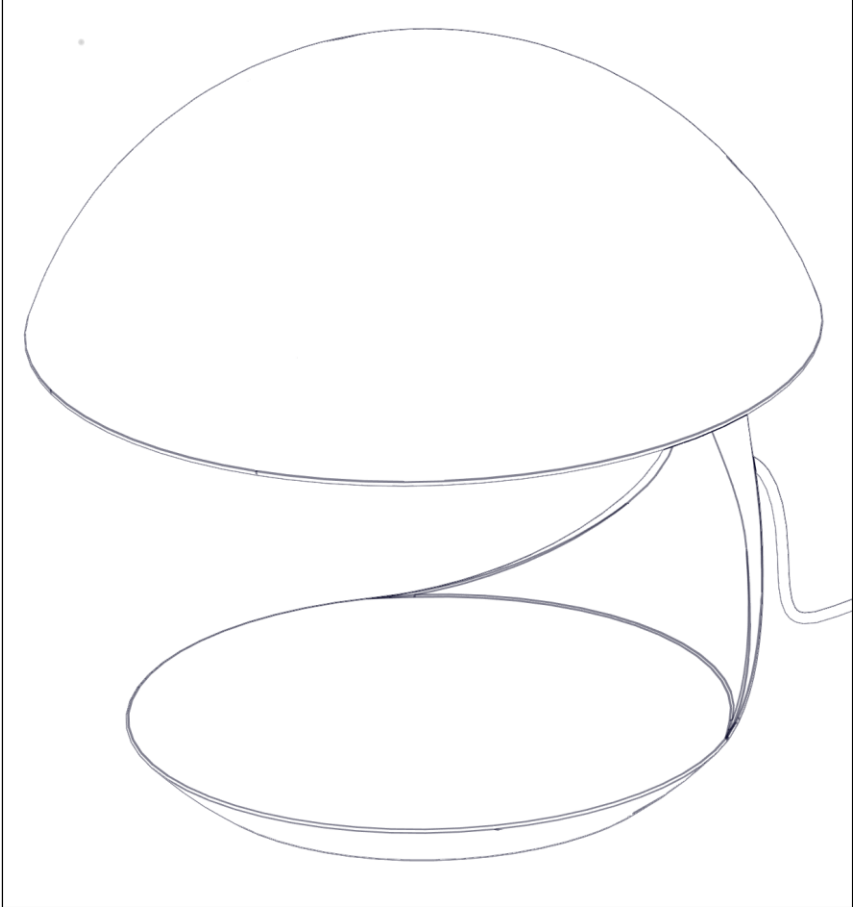

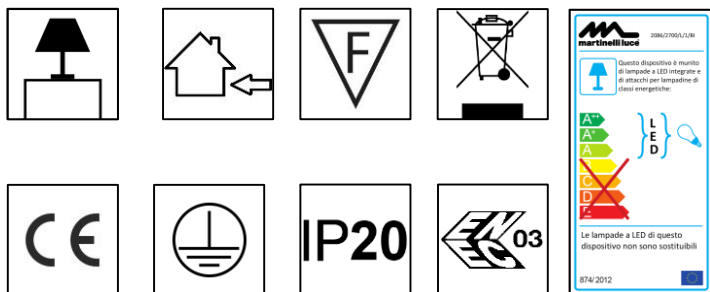

x 1

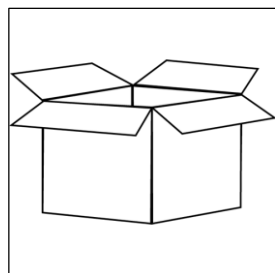

x 1

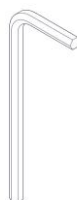

x 1

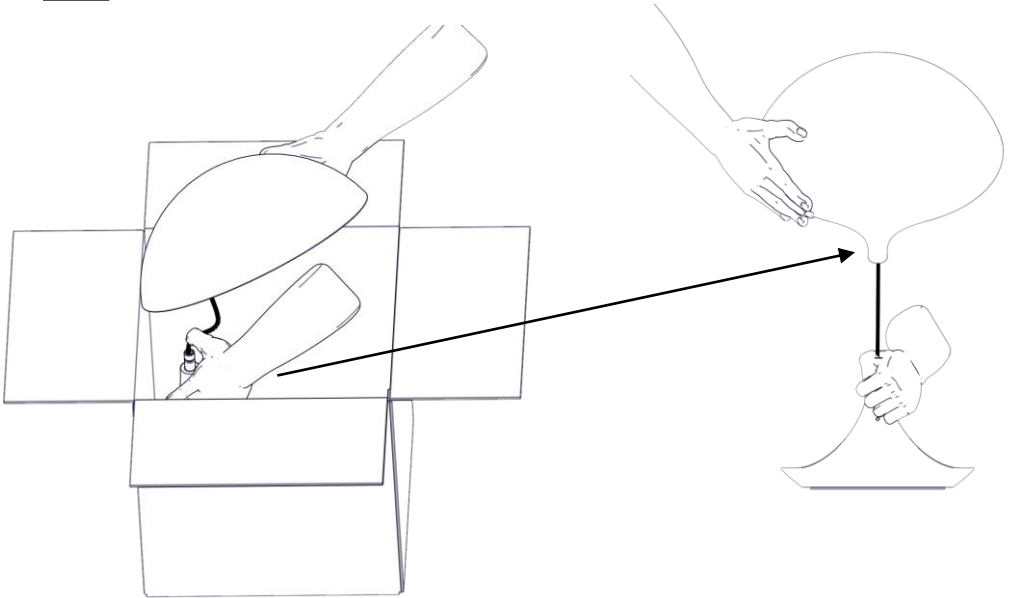
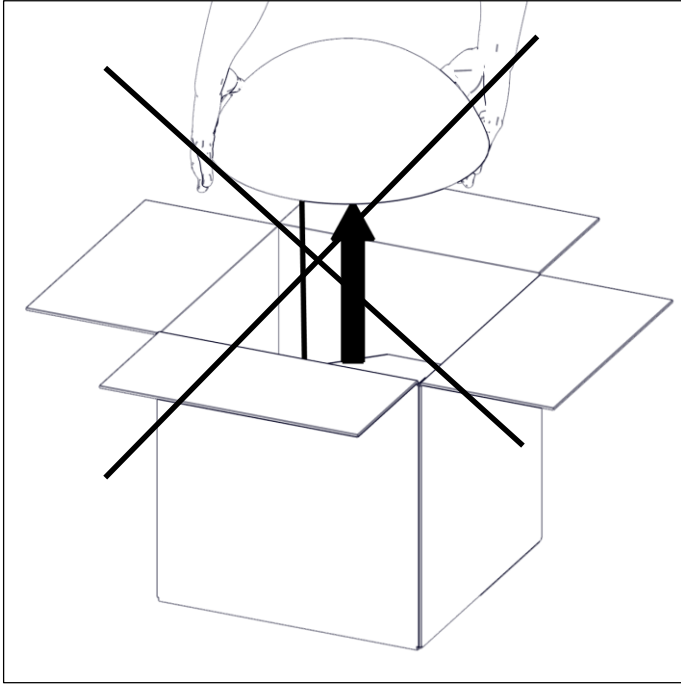

1

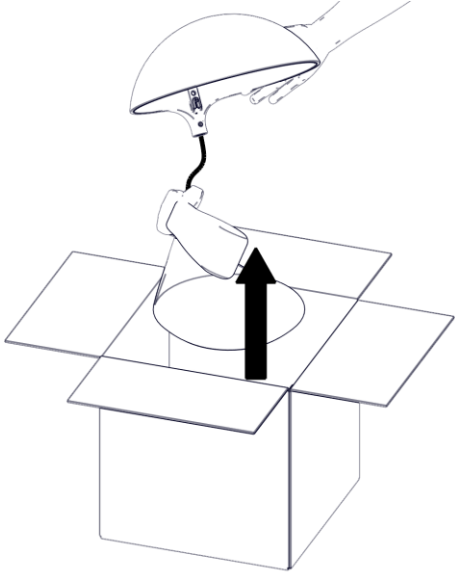

2

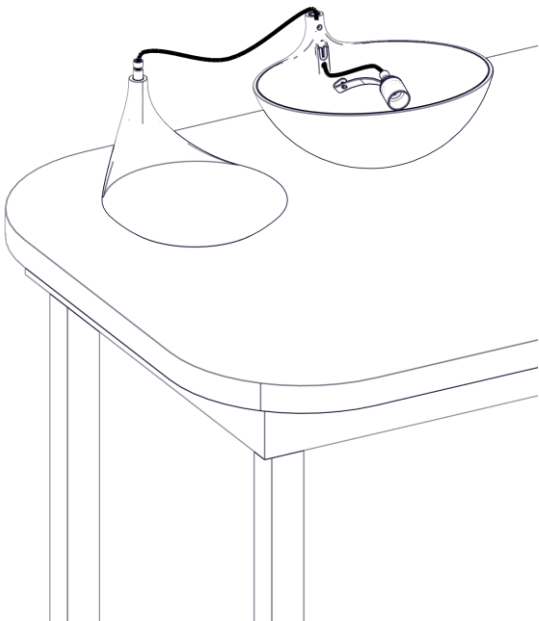

3

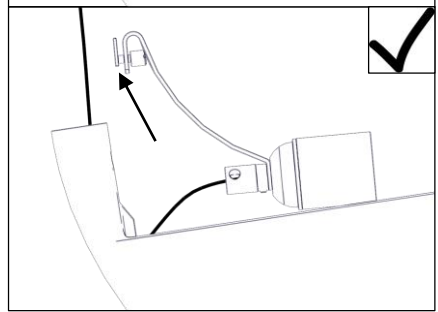
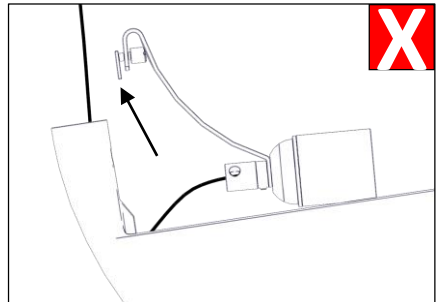
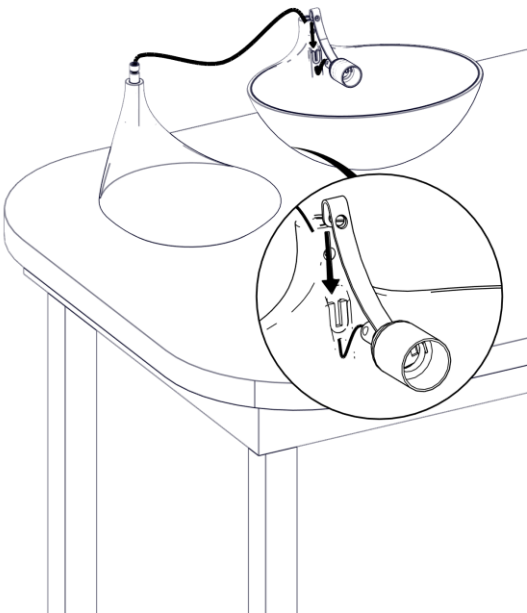

4

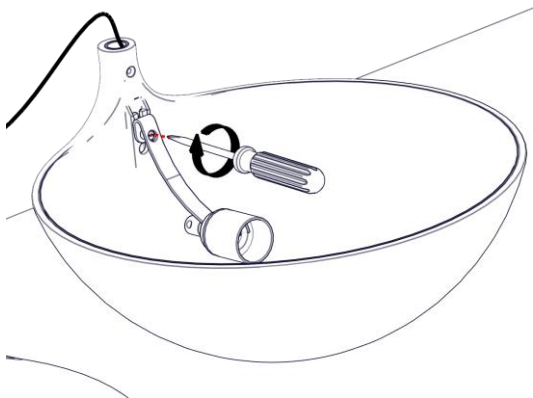

5



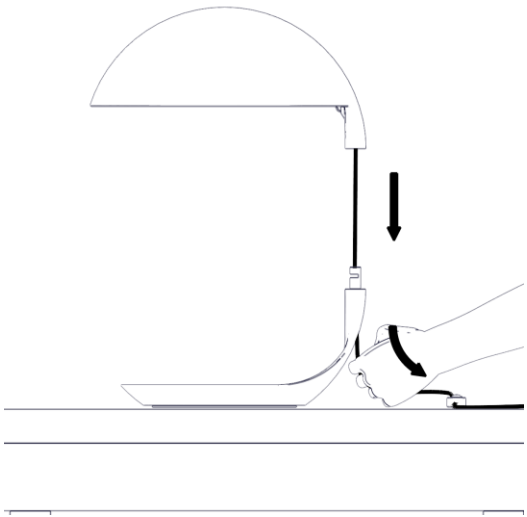

6

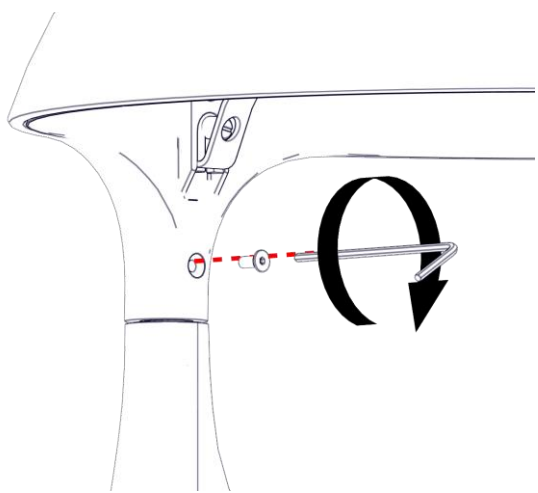

7

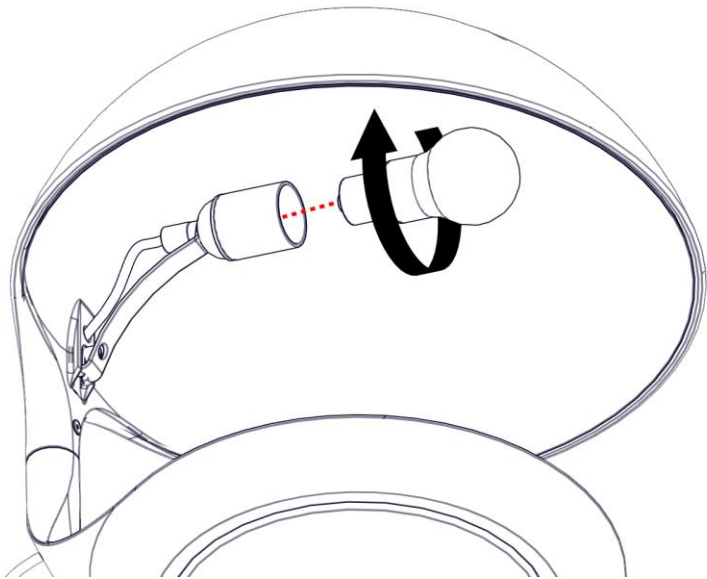



 9 W LED E27

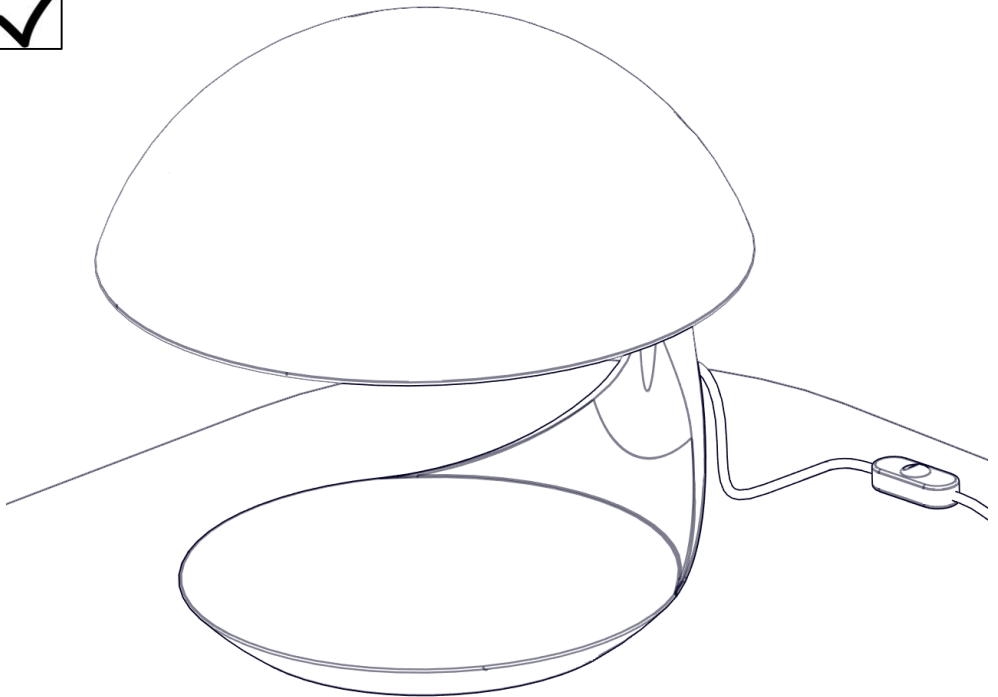

i

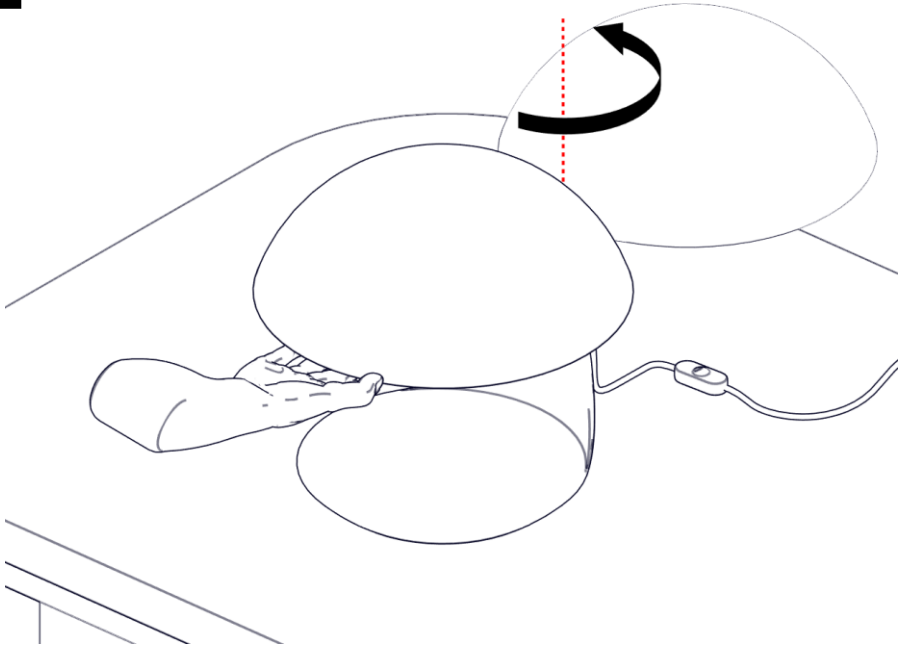

i

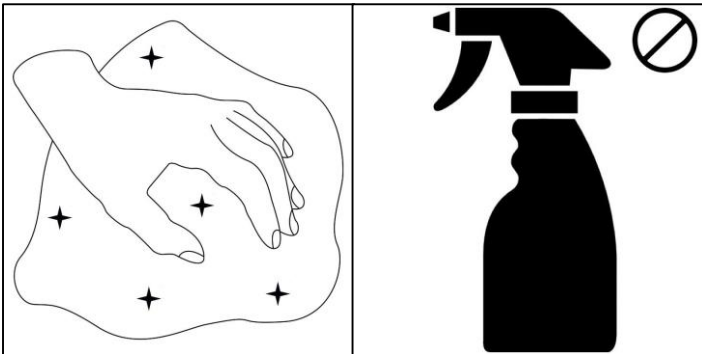

martinelli luce

Via Teresa Bandettini
55100 Lucca (Lu) – Italy

Tel.+39/0583.418315
Fax. +39/0583.419003

www.martinelliluce.it
info@martinelliluce.it